



WENDELBO

CINDER BLOCK

DESIGN BY

LUCA NICHETTO



TECHNICAL SPECIFICATIONS

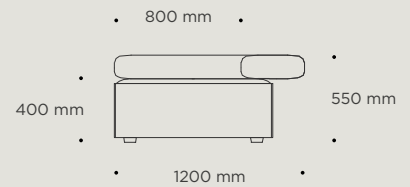

STRUCTURE INTERIOR

Frame made of solid wood and MDF with nozag spring system.

STRUCTURE PADDING

High resilient, variable density, polyurethane foam.

SEAT

High resilient, variable density, polyurethane foam. Cover of fiber-fill on top.

BACK

High resilient, variable density, polyurethane foam. Cover of fiber-fill on top.

COVER

Fixed.

LEGS

Black stained solid wood.

MAINTENANCE

We recommend shaking and fluffing-up the cushions regularly to maintain the shape. For maintenance of fabric and leather, please contact your retailer. <https://wendelbo.dk/maintanance-and-care/>

CINDER BLOCK

MODULES

Module 1
1 seater, left arm

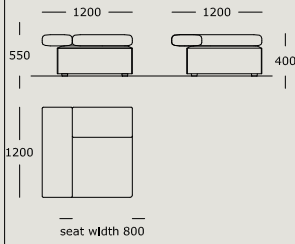

Module 2
1 seater, right arm

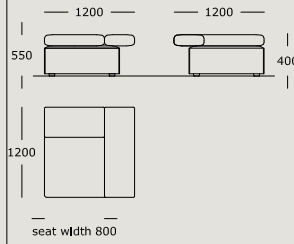

Module 3
1 seater, end-terminal, right

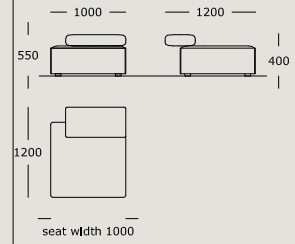

Module 4
1 seater, end-terminal, left

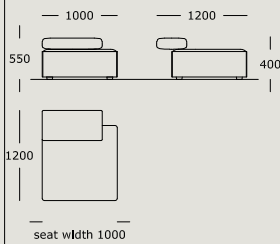

Module 5
Small center

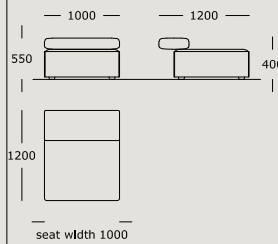

Module 6
Long center

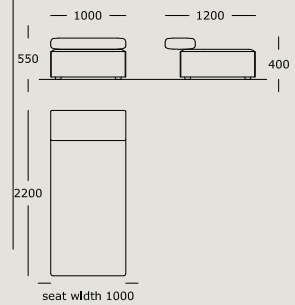

Module 7
Small stool

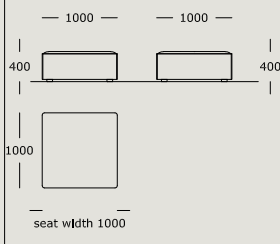

Module 8
2 seater, terminal, left arm

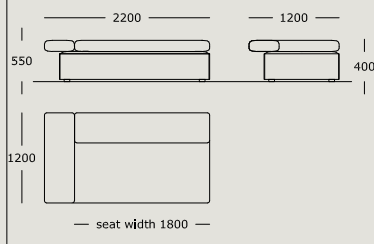

Module 9
2 seater, terminal, right arm

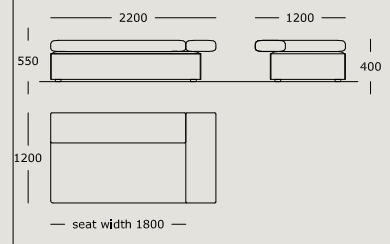

Module 10
2.5 seater, end-terminal, right

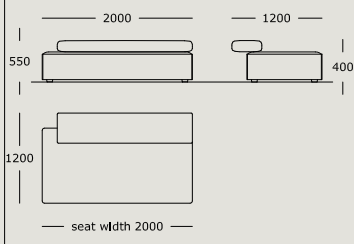

Module 11
2.5 seater, end-terminal, left

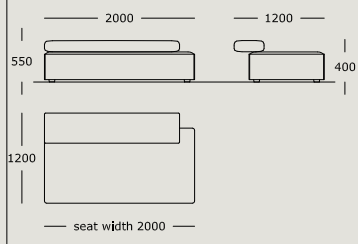

Module 12
Large center

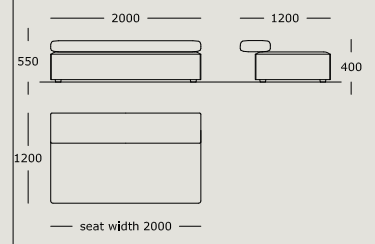

Module 13
2 seater, chaise left

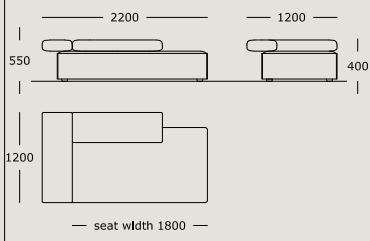

Module 14
2 seater, chaise right

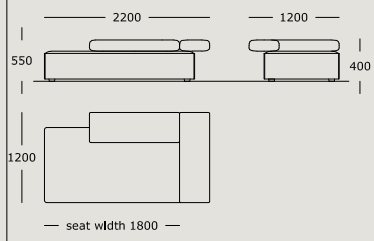

Module 15
Long stool

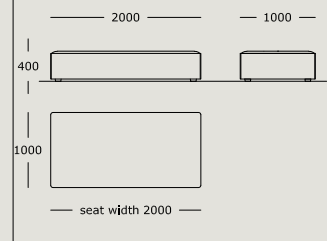

CINDER BLOCK

MODULES

Module 16
1.5 seater, left arm

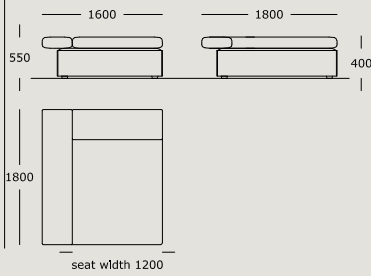

Module 17
1.5 seater, right arm

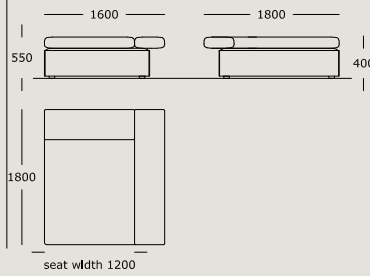

Module 18
1.5 seater, end-terminal, right

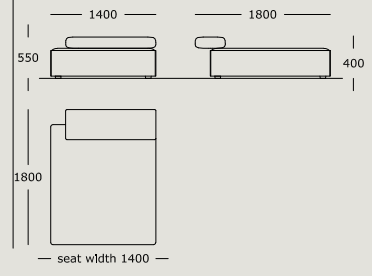

Module 19
1.5 seater, end-terminal, left

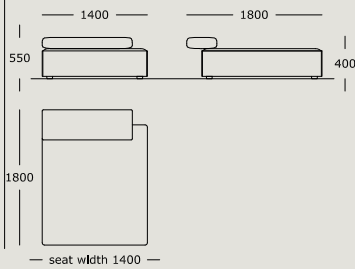

Module 20
1.5 seater, chaise left

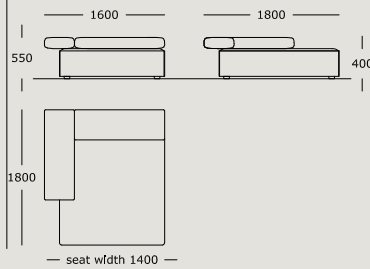

Module 21
1.5 seater, chaise right

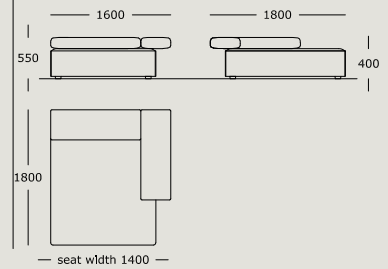

Module 22
Large center

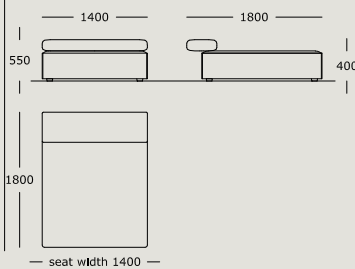

Module 23
Large stool

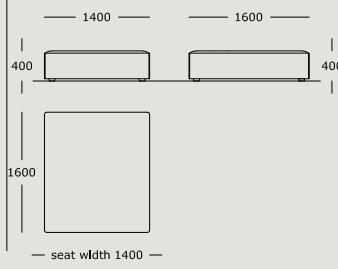

Module 24
1.5 seater, chaise no back, small arm

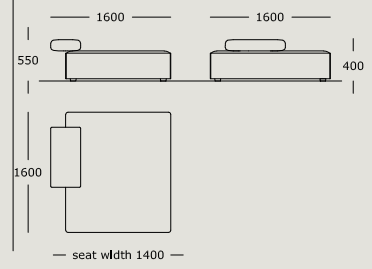

Module 25
1.5 seater, chaise no back, small arm

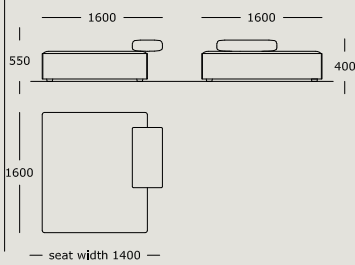

Module 26
1.5 seater, chaise no back, medium arm

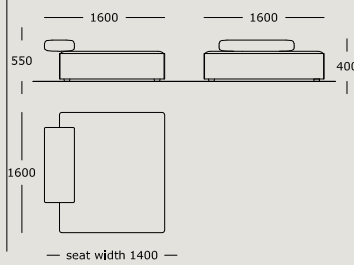

Module 27
1.5 seater, chaise no back, medium arm

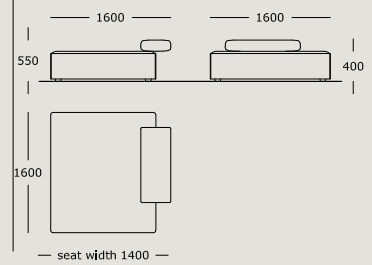

Module 28
1.5 seater, chaise large

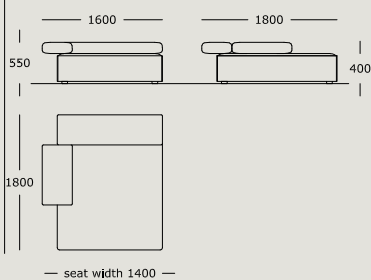

Module 29
1.5 seater, chaise large

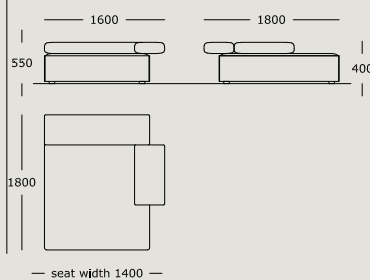

Module 30
1.5 seater, chaise large

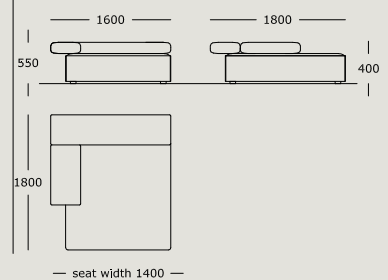

CINDER BLOCK

MODULES

Module 31
1.5 seater, chaise large

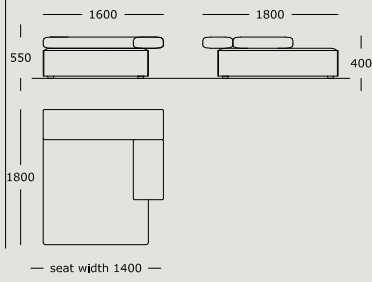

CINDER BLOCK

CONFIGURATION INSPIRATION

Suggestion 01

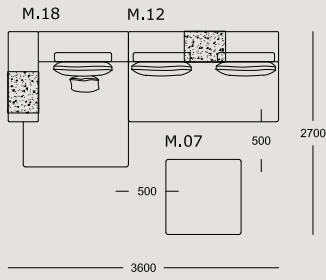

Suggestion 02

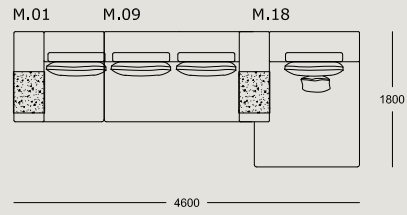

Suggestion 03



Suggestion 04

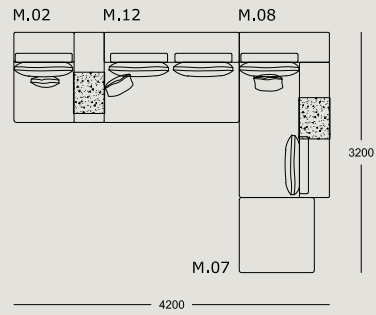

Suggestion 05

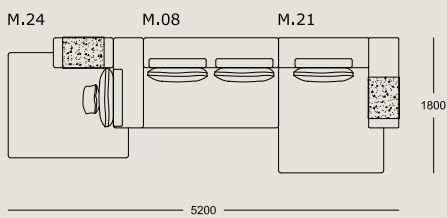

Suggestion 06

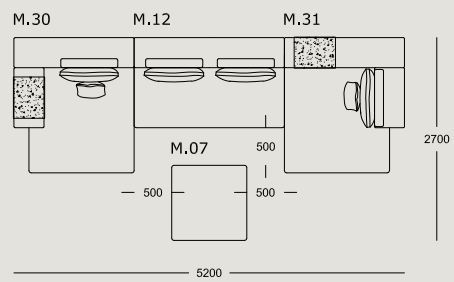

Suggestion 07

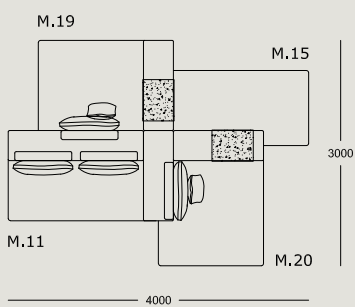

Suggestion 08

